

Carbonhand®

USER MANUAL

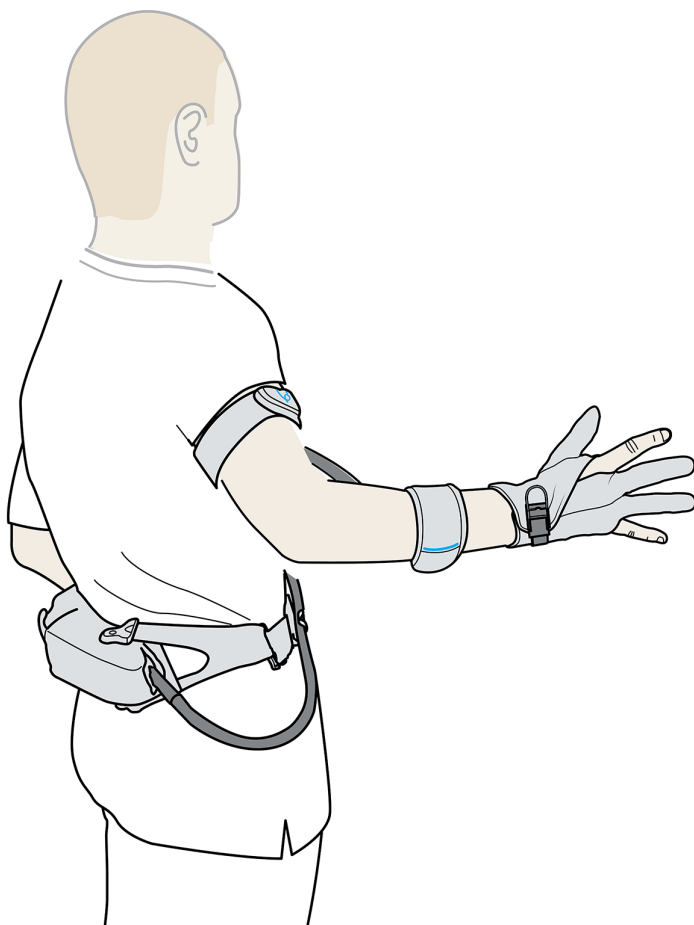

TYPE: C0

 BIOSERVO

Table of Contents

1.	Introduction	4
1.1	About this manual	4
1.2	Intended use	4
1.3	Limitations of Use	4
1.4	Intended User	4
1.5	Introduction to Carbonhand	4
1.6	Conformity	5
1.7	Symbols on Carbonhand	6
1.8	Labels	7
1.9	Disposal	7
2.	Safety	8
2.1	Precaution	8
2.2	Definitions	8
2.3	General	8
2.4	Warnings	9
2.5	Cautions	10
3.	Product overview	11
3.1	Carbonhand	11
3.2	Power unit	12
3.3	Glove	13
3.4	Battery Charger	15
4.	To assemble Carbonhand	16
4.1	To connect the glove to the Power unit	16
4.2	To prepare the Carry solution	16
4.3	To assemble the Hip and Back carry	17
5.	To charge Carbonhand	19
6.	To calibrate your Carbonhand	20
7.	To put on Carbonhand	21
7.1	To put on the Hip carry and Back carry	21
7.2	To put on the Armstraps	22
7.3	To put on the glove	22
7.4	To remove the glove (Quick release)	23
8.	To use Carbonhand	24
8.1	User environment	24
8.2	Hygiene	24
8.3	Inspections and service	25

8.4	Daily function test	25
8.5	Storage	25
9.	To start and turn off Carbonhand	26
10.	Profile selection and lock assist	27
10.1	Profile Selection	27
10.2	Lock assist	27
11.	Bioservo App	28
11.1	How to connect	28
11.2	General settings	29
11.3	Create a new profile	30
11.4	Edit profiles	31
11.5	Linking sensors	32
11.6	My Activity	33
11.7	Remote configuration	35
12.	To clean Carbonhand	37
12.1	To clean the glove	37
12.2	To clean the arm straps	38
12.3	To clean the carry solution	38
12.4	To clean the Power unit	38
13.	Carbonhand parts	39
13.1	Accessories	40
14.	Troubleshooting	41
15.	Technical specifications	42
16.	Declaration of Conformity	43

1. Introduction

1.1 About this manual

Read the entire user manual before you operate the product. Always keep the user manual in a place where you can easily find it. If you lose the user manual contact your supplier.

1.2 Intended use

Carbonhand type C0, hereafter referred to as Carbonhand is intended to enhance the ability to perform activities in daily living for people (from children to elderly people) with impaired hand function. Carbonhand mimics the user's grip movements and supports the user's natural grip.

1.3 Limitations of Use

People with severe spasticity have difficulties opening their hand and will not benefit from using the glove since Carbonhand only facilitates closing of the hand.

1.4 Intended User

People with self perceived impaired hand function and/or reduced grip strength are considered to be the operators of Carbonhand.

1.5 Introduction to Carbonhand

Carbonhand is an grip-strengthening glove that mimics the anatomy of the hand and provides support to people with impaired hand function. The system consists of a glove with built in pressure sensors in the fingertips, middle phalanges and the palm that detects when the user initiates a grip and passes the information on to a sophisticated control system that calculates the forces and pulls artificial tendons that are sewn into the glove.

The forces are calculated every 5th millisecond by the microprocessors in the Power unit, and adjusts the tension in the artificial tendons to follow every movement from the user, e.g. using a bottle to fill liquid into a glass, carrying objects, or doing other daily activities.

The behavior of the glove can be highly customized by using an app, eg the responsiveness, maximum force and stickiness, enabling the glove to support patients with a wide variety of hand impairments.

For users with a very low hand function, the “Lock assist” can be used to initiate a grip using a built-in button or an external trigger. When activating the Lock Assist, Carbonhand will initiate a grip and hold it until the button is pressed again.

Carbonhand is designed to fit as many patients as possible. The open design of the glove makes it easy to put on and take off. The initial positions of the tendons are calibrated to fit the hand of each user, and the unique design of both the Power Unit and Carry Solution means that Carbonhand can be adjusted to be worn on the back, the hip, a wheelchair or any other way that suits the user.

The impact of Carbonhand is immediate. With an applied force of up to 20 Newtons (N) per finger, a large proportion of patients with impaired hand function are able to regain their hand function and resume activities in their daily life. With the Carbonhand a more immediate compensation of the handicap takes place in that objects can be grasped, held and carried directly with the pathological hand again. It serves to mobilize and stabilize the hand and thus to ensure safe and sustained direct grasping. The Carbonhand is used to compensate for and secure the function of the hand.











1.6 Conformity

Carbonhand compliance:

ANSI/AAMI ES60601-1:2005/(R)2012
IEC 60601-1-11:2015+AMD1:2020
IEC 60601-1-2:2014+AMD1:2020
CFR Part 15 Class B

See charger manual







1.7 Symbols on Carbonhand

Symbol	Description	Symbol	Description
	Manufacturer's reference number Power unit Manufacturer's reference number Glove		Keep the product dry
	Manufacturer		Do not discard as household waste.
	User manual must be read before use	R only	Caution: Federal law restricts this device to be used under the order by a physician Only applicable in the U.S
IP22	Ingress protection - The Carry solution provides some protection against water but contact with liquid should always be avoided.		Medical Device
(21)	Serial number Power unit Serial number Glove	(11)	Manufacturing date: YYYYMMDD
	Device classified as type BF applied part	(01)	UDI-DI Power Unit UDI-DI Glove
	Consult user manual		Europe
	Australia		



1.8 Labels

Power unit

 **BIOSERVO Carbonhand** Made in Sweden

V 8.2 ---      





IP22
Type: C0  R only

 **REF** TI-000110 (01)07350082160011
(21)BH00257
(11)240212 

Bioservo AB
Torshamnsgatan 35, Kista Sweden

Glove

 **BIOSERVO Carbonhand**

    R only **REF** TI-000113

Type: C0
Size: RM
Assembled in Poland (01)07350082160097
(21)QC00170
(11)240212 

 Bioservo AB
Torshamnsgatan 35, Kista Sweden

1.9 Disposal

When disposing of Carbonhand, it should be recycled as electronic waste according to local regulations.

2. Safety

2.1 Precaution

Depending on the nature of the users hand impairment it is recommended to start using the Carbonhand gradually to avoid overexertion.

2.2 Definitions



Warning! Risk of injury if instructions are not followed.



Caution: Risk of material damage if instructions are not followed.



Information for optimal use of equipment.

2.3 General

Read the manual before starting to use Carbonhand. Any serious incident related to Carbonhand should be reported to Bioservo AB and the competent authority where the incident occurred. Bioservo is not responsible for personal injuries or property damage resulting from any person's failure to follow the warnings and instructions in this manual. Bioservo is not responsible for injuries or damage resulting from failure to exercise good judgment.

2.4 Warnings

- Do not rely on Carbonhand in hazardous situations such as but not limited to; holding a heavy container with hot liquid, handling firearms, operating vehicles or power tools that can cause injury.
- Always make sure that you can safely control the situation should Carbonhand stop working.
- Be careful when handling fragile objects.
- Use caution when operating Carbonhand in environments with high levels of radio frequency noise, such as near welding equipment.
- Do not handle burning material or deal with fire while wearing Carbonhand.
- Dress any open wounds or use a protective glove inside Carbonhand.
- If you suffer from a swollen hand, let the swelling go down before using Carbonhand.
- If you have reduced sensory function, check your hand for any discoloration or swelling when using Carbonhand. Deactivate the glove and continue once the symptoms have receded.
- If you experience tingling, numbness, swelling or a change of color during a prolonged static grasp deactivate the glove and continue once the symptoms have receded.
- Always follow the instructions of your doctor or therapist.
- Don't overexert your hand. New users should increase the use of Carbonhand gradually.
- Stop using Carbonhand if it causes pain or discomfort. Consult a physician if the condition persists after 24h.
- Wear Carbonhand as instructed in this manual to avoid entanglement.
- Only use Carbonhand on the hand it is intended for.
- Carbonhand does not provide protection. Use a protective outer glove if it is necessary.
- If Carbonhand malfunctions, pull the loop on the glove to quickly release the grasp.
- Do not do modifications to Carbonhand. Modifications can make the device unreliable and can cause short circuit and fire.
- Carbonhand is not a toy, do not let children play with it. The glove cord may cause strangulation.
- If you experience an allergic reaction, stop using Carbonhand and contact your supplier.
- Carbonhand contains small and loose parts that can cause suffocation, keep away from children and pets.

2.5 Cautions

- Use Carbonhand according to the instructions. Incorrect handling can cause discomfort and void the warranty.
- If the glove could become dirty or wet, use a protective glove over Carbonhand.
- All service work must be done by an authorized technician.
- Do not expose Carbonhand to temperatures above 60°C/140°F.
- Do not use Carbonhand if it shows signs of damage.
- The charger could cause interference with other electric devices. Contact the Carbonhand supplier if you encounter a problem.
- Always use and store Carbonhand in the carry solution.
- Avoid creating sharp bends to the Glove cord or put heavy objects on it.
- The battery must not be replaced by the user. If the battery needs to be replaced send Carbonhand to your supplier.
- Always keep Carbonhand clean. Do not touch anything that could cause resistant stains.
- Keep Carbonhand away from liquids and small particles.
- Do not use portable RF communications equipment, like mobile phones, closer than 30 cm (12 inches) to the Carbonhand power unit. Otherwise, the performance of Carbonhand can deteriorate.
- Only use the charger specified in this manual.
- Never use the charger with a damaged cable.
- Always keep the charger and magnetic connector clean, free from dust and away from liquids.
- Do not dismantle or do modifications to the charger.
- If you have any problems with the charger while it is connected to the power outlet disconnect it immediately.
- Connect the charger to the power outlet before attaching the magnetic connector to the Power unit .
- Unplug the charger from the power outlet when not in use.

3. Product overview

3.1 Carbonhand

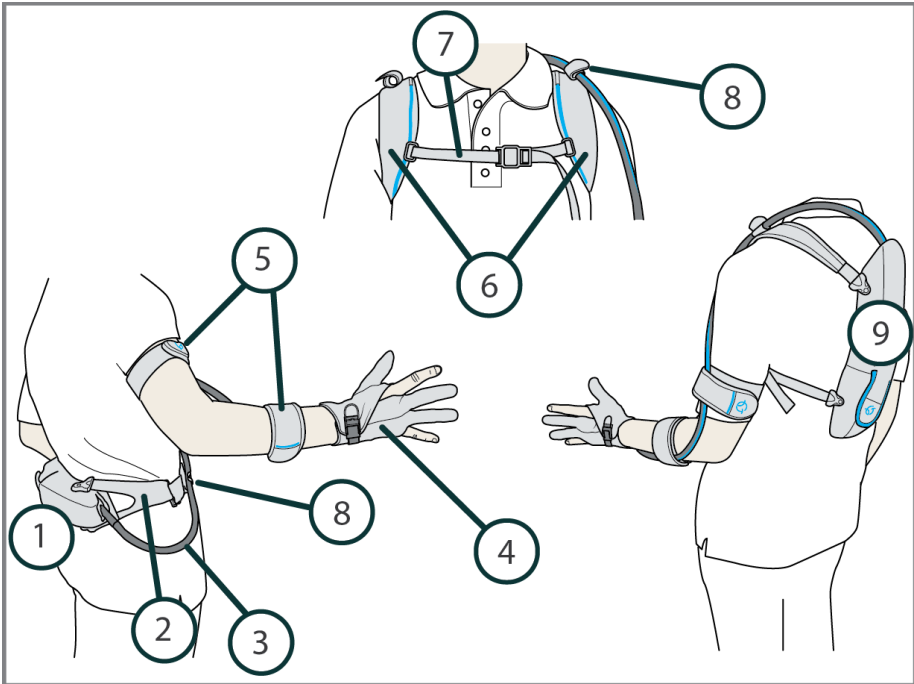

Item	Name	Function
1	Hip carry	Used to carry and protect the Power unit when carrying it on the hip
2	Belt	Used for hip carry solution
3	Glove cord	Transmits sensory data and provides force
4	Glove	Provides grasp force
5	Arm straps	Keeps the Glove cord attached to your arm
6	Shoulder straps	Used for back carry solution
7	Sternum strap	Connects the shoulder straps
8	Cord clips	Holds the cord in place
9	Back carry	Used to carry and protect the Power unit when carrying it on the back

3.2 Power unit



A carry solution must always be used to prevent damage to the Power unit

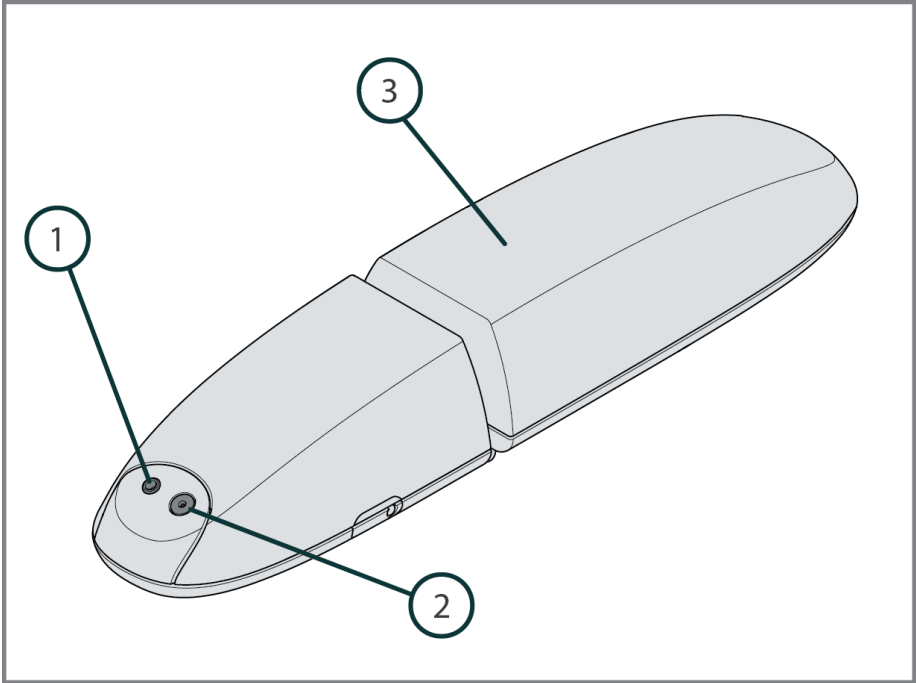

Item	Name	Function
1	External activation input (3.5 mm)	External activation of lock assist
2	Magnetic connector	Connector for charger
3	Power unit	Controls and powers Carbonhand

3.3 Glove

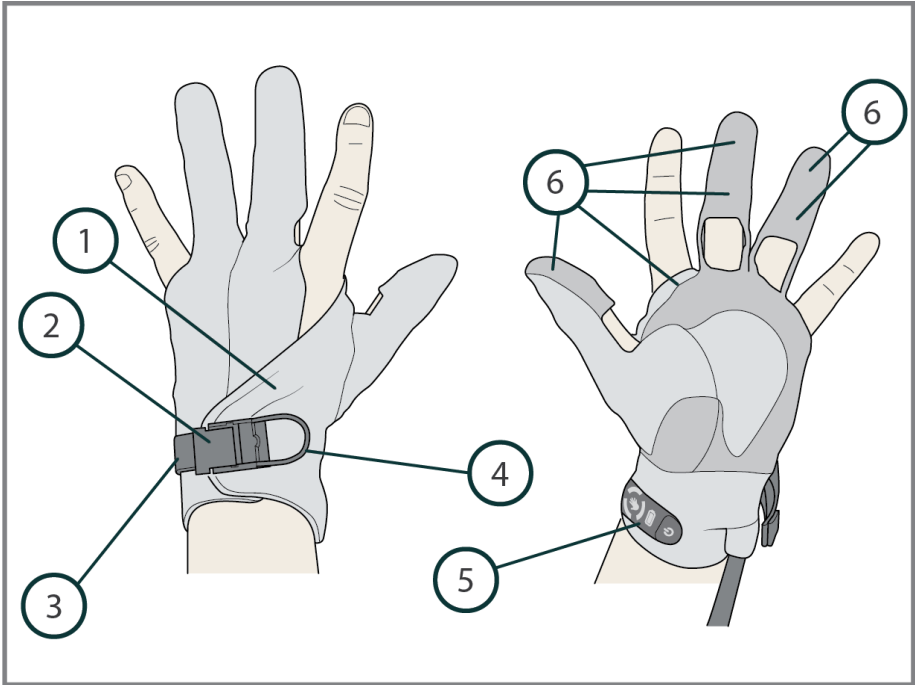

Item	Name	Function
1	Glove	Provides grasp force
2	Buckle	Holds and loosens the strap
3	Wrist strap	Keeps the glove closed
4	Loop (Quick release)	Used to remove the glove
5	Control pad	Used to control the glove
6	Sensors	Transmits data to the Power unit

3.3.1 Control pad

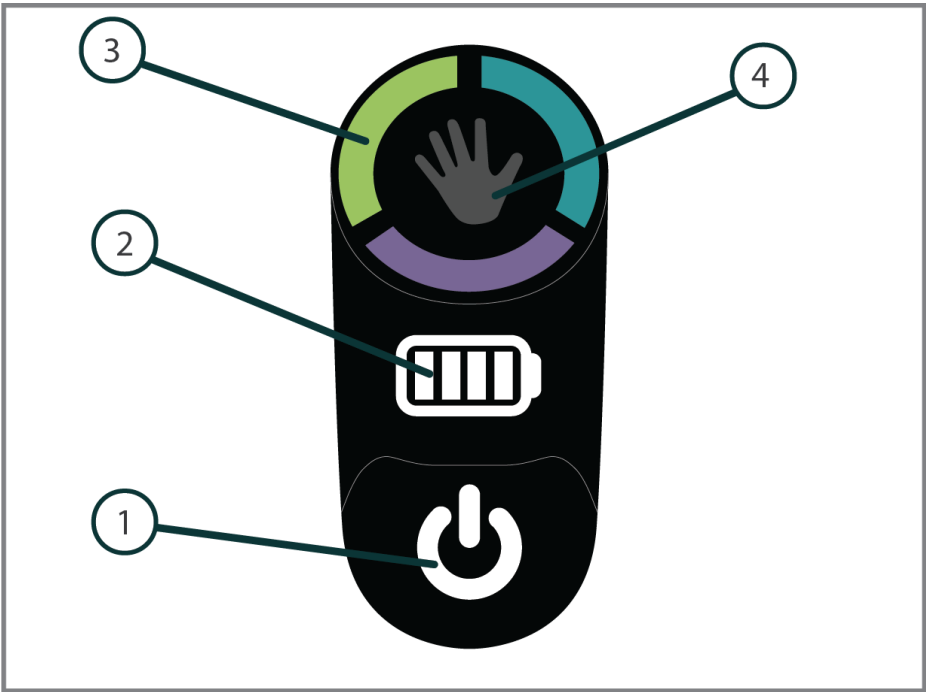

Item	Name	Function
1	On/off button	Turns the device on and off
2	Battery indicator	Indicates the battery level
3	Profile indicator	Indicates which profile is active
4	Hand button	Press and hold to change profile. Short click triggers lock assist if activated in the Bioservo App

3.4 Battery Charger

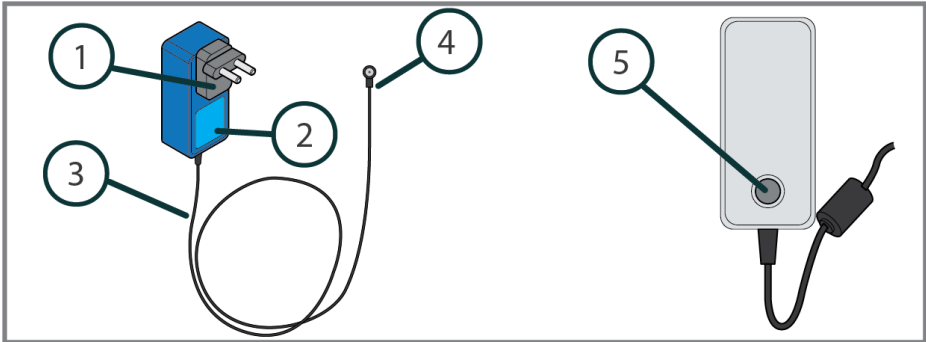

Item	Name	Function
1	AC-plug	Plug options: EU, U.S and U.K
2	Power adapter	Charges the battery, Converts AC to DC
3	Charger power cable	Transmits DC voltage to the battery
4	Magnetic connector	Attaches to Power unit and charges the battery
5	Charging indicator	Indicates charger status

Note: The AC-plug may vary to fit the requirements of specific countries.

Charging indicators.

Light indicator	Meaning
Yellow	The battery has started charging
Yellow flashing	The battery is charging
Green flashing	No battery connected or connected battery fully charged
Red flashing	Error. Unplug the charger and contact your supplier

For more information see the label on the charger.

4. To assemble Carbonhand

4.1 To connect the glove to the Power unit

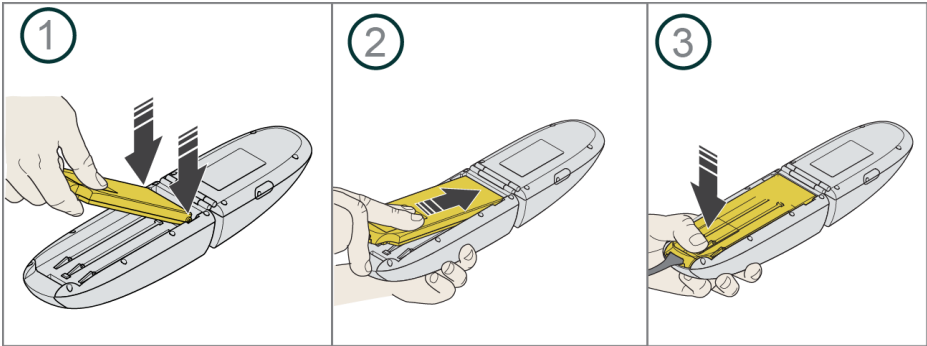

4.2 To prepare the Carry solution

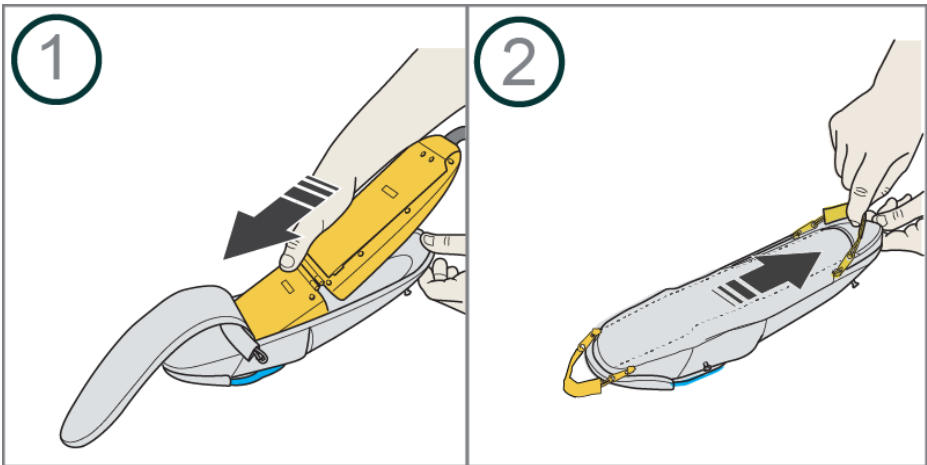

4.3 To assemble the Hip and Back carry



Caution: Make sure that the buckles are closed all the way before putting on the carry solution.

4.3.1 Hip Carry

It is recommended to attach the belt strap with the magnetic buckle on the same side as the intended users non affected hand.

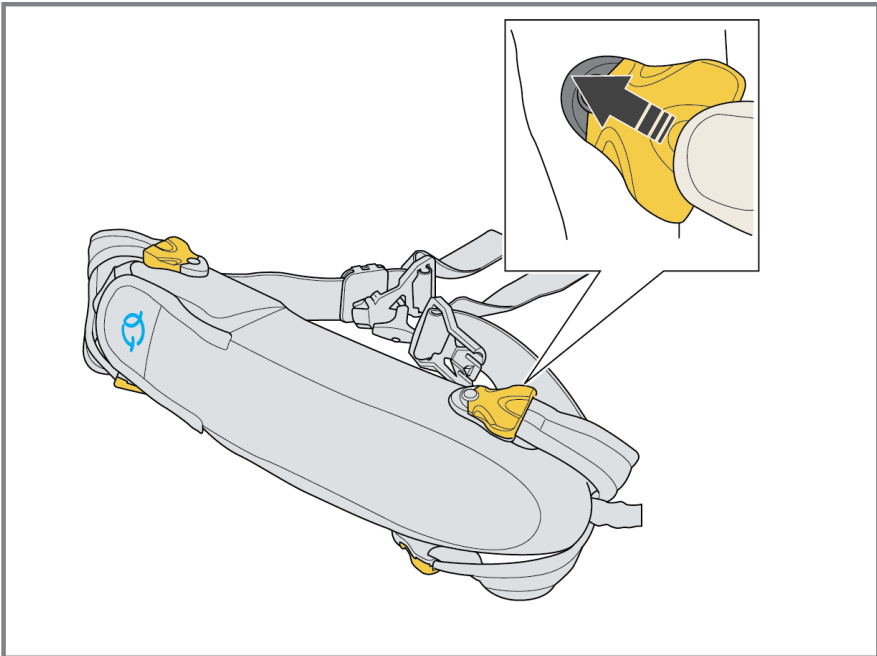

4.3.2 Back Carry



Caution: Make sure that the buckles are closed all the way before putting on the carry solution.

The shoulder straps and carry solution are both color coded in order to let the user know which direction the shoulder straps should be attached. Role up any excessive parts of the strap to avoid entanglement.

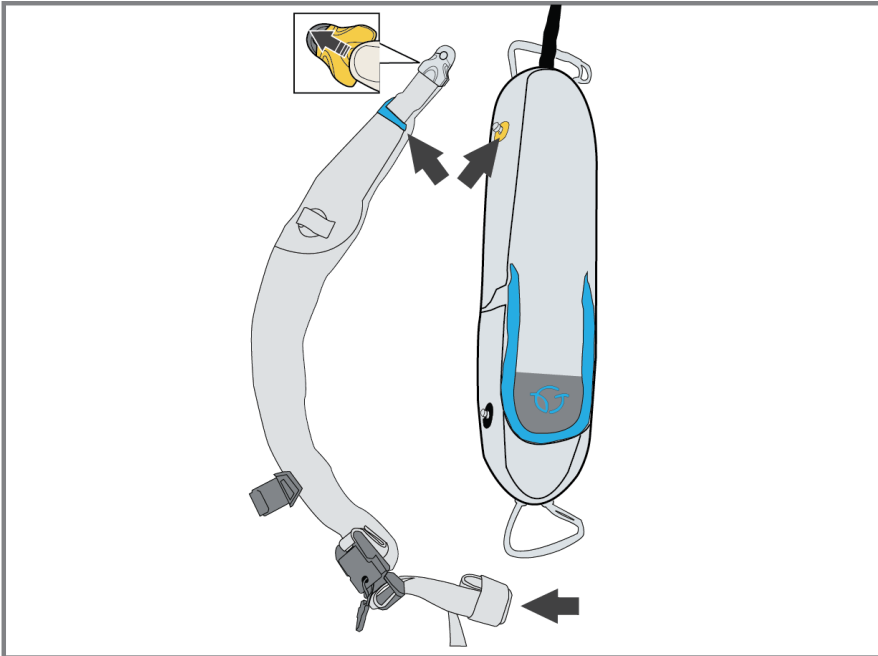

5. To charge Carbonhand

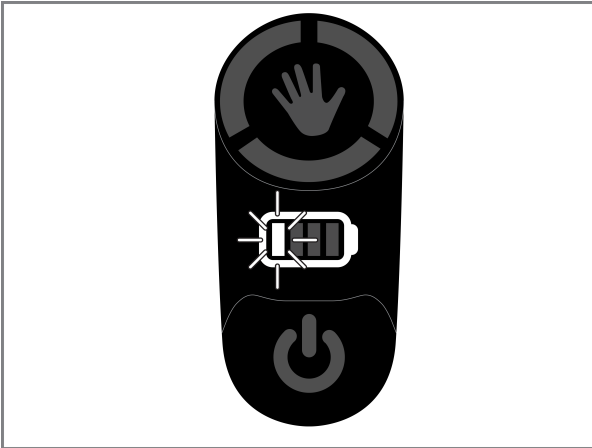

When the battery level is low a visual and acoustic reminder will indicate that Carbonhand needs to be charged. The acoustic reminder will increase in intensity when the battery level becomes critical.



The charger becomes warm during use.

Put Carbonhand in stand-by mode or complete shut down before charging. Make sure that both Carbonhand and the charger are easily accessible and visible while charging. If you experience problems during charging, remove the charger from the power outlet. For additional information regarding charging indicators see chapter 3.4. Charge time: Approximately 2 hours (from a depleted battery).

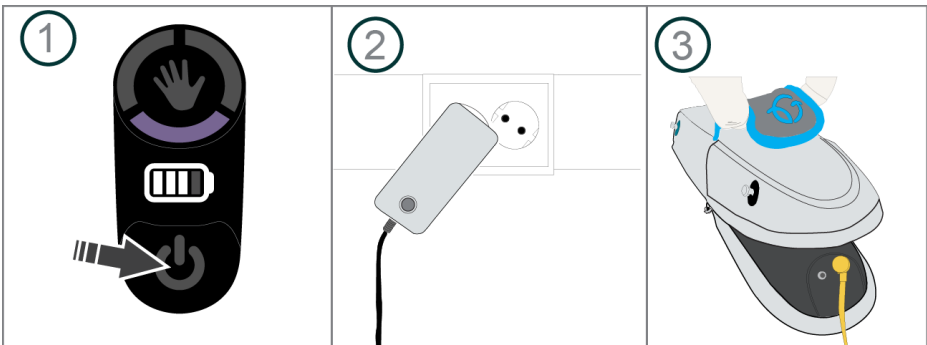

6. To calibrate your Carbonhand

To adjust the Carbonhand glove to fit your hand and to get the maximum effect you need to calibrate the glove. When connecting to the app for the first time you will be required to calibrate the glove. This is done through the Bioservo app. See [chapter 11](#) "General Settings" for more information.

1. Connect your Carbonhand to the Bioservo app. See General Settings in [chapter 11](#).
2. Place the glove on the affected hand. To ensure a correct fit, It is important that there is no space between the tip of your fingers and the glove since it can affect the precision of the sensors.
3. Place your hand on a flat surface with your fingers stretched out as far as you can.
4. Press start calibration. Carbonhand will now adjust the length of the tendons to fit your hand.

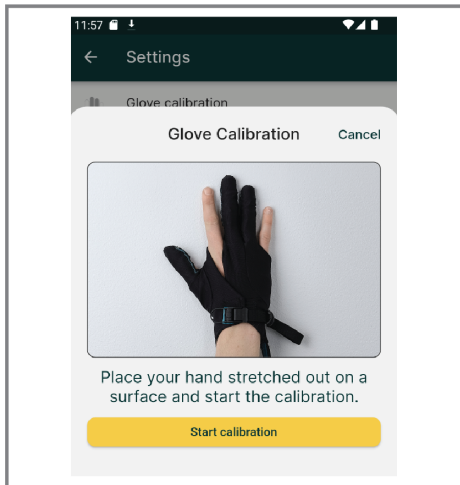

7. To put on Carbonhand



Caution: The added force can be surprising for a new user. Make sure you familiarize yourself with this extra force before you start making full use of the Carbonhand.

7.1 To put on the Hip carry and Back carry

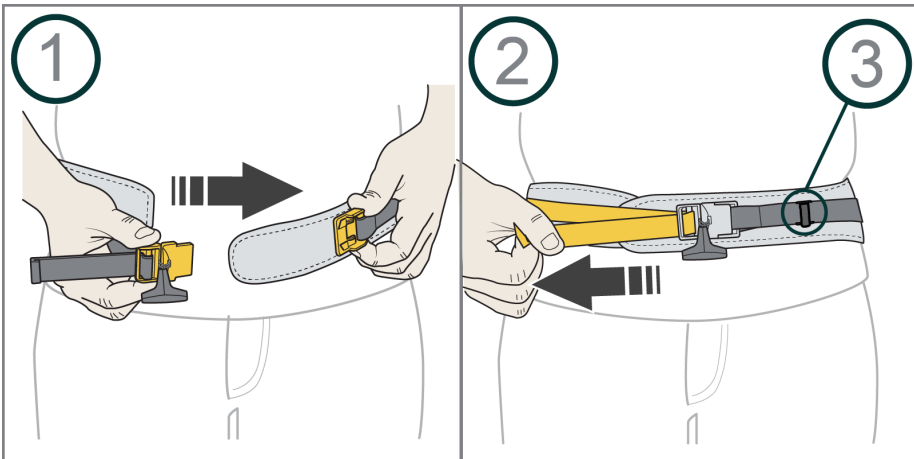

Note: 3 Attach the glove cord to the cord clip to avoid entanglement.

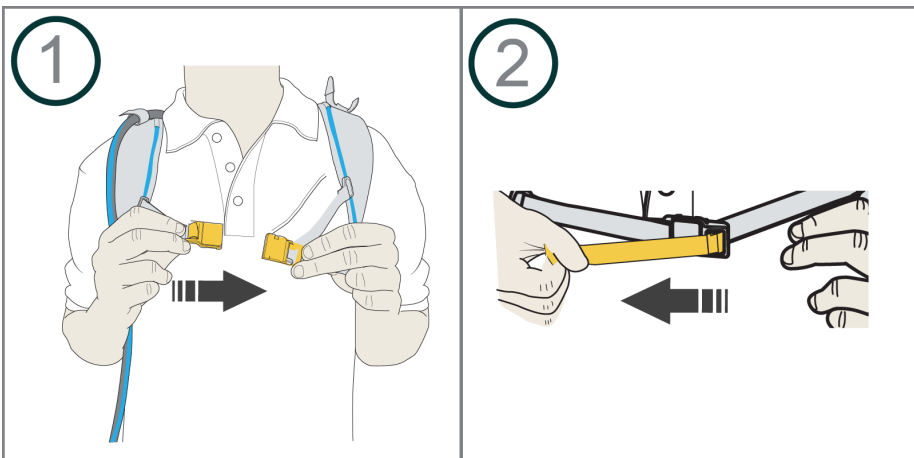

7.2 To put on the Armstraps

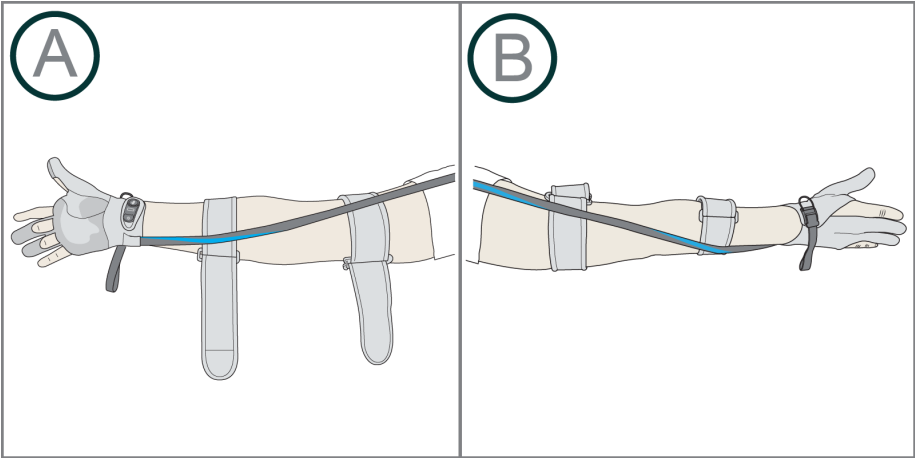

When using the hip carry, place the glove cord on the inside of your arm. See illustration A. When using the back carry, place the glove cord on the outside of your arm. See Illustration B.

7.3 To put on the glove

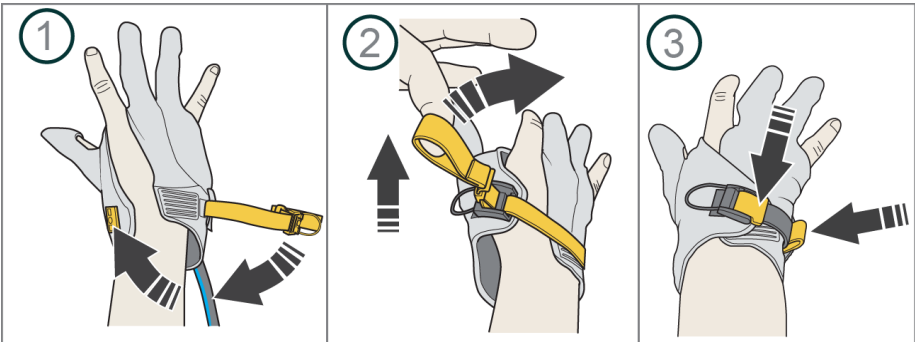

7.4 To remove the glove (Quick release)

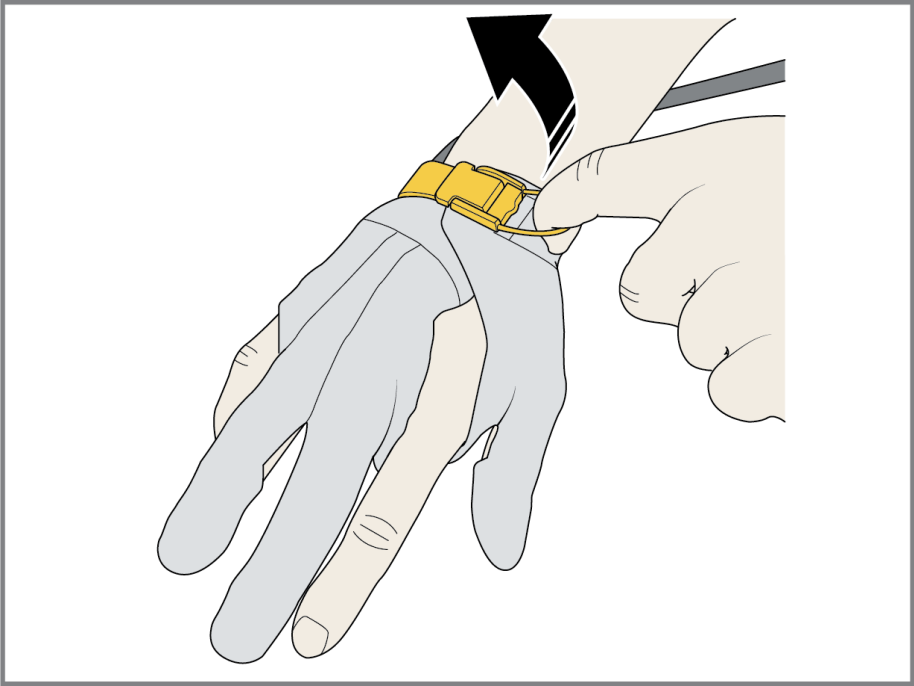

8. To use Carbonhand



Warning! Use Carbonhand according to the instructions in this manual. Incorrect handling can cause discomfort.

8.1 User environment

Lint, dust and other particles can have a negative impact on Carbonhand. Always use and store Carbonhand in the intended carry solution. Avoid using Carbonhand in extremely warm and humid environments, for example a sauna. Use a protective glove over Carbonhand when performing tasks that can make Carbonhand dirty or wet, such as washing dishes by hand. Detergents, fat and grease can have a negative effect on the gloves sensors. When not using Carbonhand make sure to store it away from children and pets and preferably in the supplied case.

8.2 Hygiene



Figure 1: Wash and dry your hands before you use Carbonhand. Use hand sanitizer if needed.

8.3 Inspections and service



Warning! All service work must be done by an authorized technician.

Inspect Carbonhand with regular intervals to make sure that it functions correctly and that there are no damages on the system components. There are no parts in the Power unit that can be replaced by the user. Contact the supplier for all service work.

8.4 Daily function test

1. Make sure that you have put on Carbonhand according to the instructions.
2. Grab an object to check that the sensors are responding and that the glove releases the object when you release the grip.
3. Now you are ready to use Carbonhand.



If the Carbonhand glove malfunctions, use the quick release to remove the glove.

8.5 Storage

Store Carbonhand in the Carry solution at room temperature. Keep away from direct sunlight, children and pets.

9. To start and turn off Carbonhand

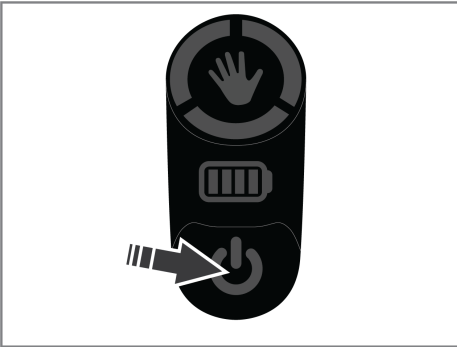

To start Carbonhand press the On/Off button and wait until the profile indicator stops blinking.

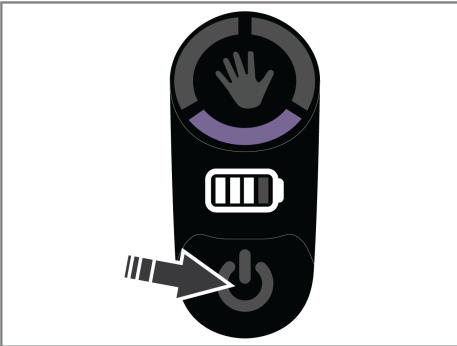

To put in pause mode perform a short click. To put in stand-by mode click and hold for 2 seconds. To do a complete shut down click and hold for 7 seconds. A visual and acoustic confirmation will indicate that Carbonhand is turned off.

10. Profile selection and lock assist

10.1 Profile Selection

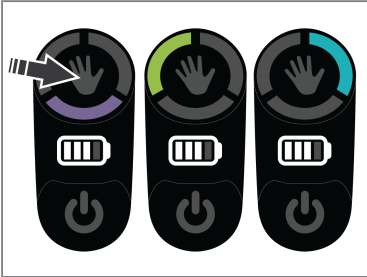

In order to cycle through the three available profiles press and hold the hand icon on the Control pad.

10.2 Lock assist

Lock assist can be activated by a short click on the hand button located on the control pad, or by an external activation button. It needs to be turned on in the app before use, see [chapter 11](#). "General settings".

If Carbonhand holds a grip when lock assist is activated, the same grip will be held until deactivated. If Carbonhand does not hold a grip when lock assist is initiated, it will initiate a grip and lock with the maximum force of the active profile. To deactivate lock assist, perform a short click on the hand button located on the control pad.

Lock assist has a time limit. After 28 minutes the system will sound and send haptic feedback through the glove. After an additional 2 minutes the system will deactivate lock assist. Lock assist can be activated again by pressing the hand button.

NOTE: Do not use lock assist in situations where you may need to release the grip quickly.

NOTE: If you experience tingling, numbness, swelling, or a change of color while using lock assist, deactivate it and continue once the symptoms have receded.

11. Bioservo App

To download the app, scan this QR-code. You will find the latest version of the manual in the Carbonhand Academy under the chapter "Customer support".



11.1 How to connect

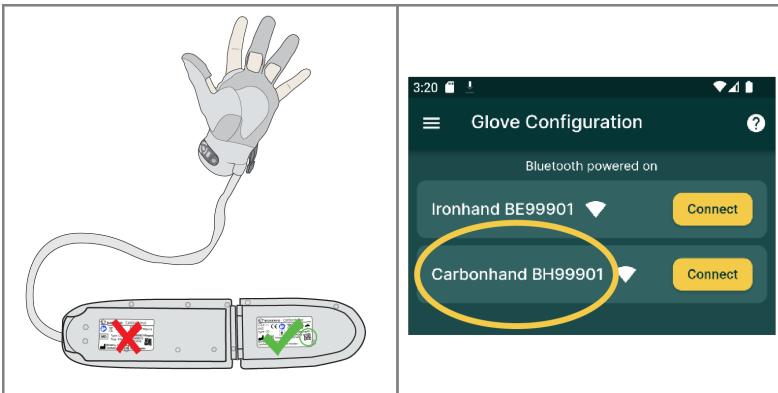

When connecting to Carbonhand for the first time, scan the QR code on the Power unit with the Bioservo App. This only has to be done once, thereafter you only have to click on "Connect" under glove configuration.

Note: If you reinstall the app or receive a new power unit the process has to be repeated. Remember to turn on Bluetooth on your mobile device.

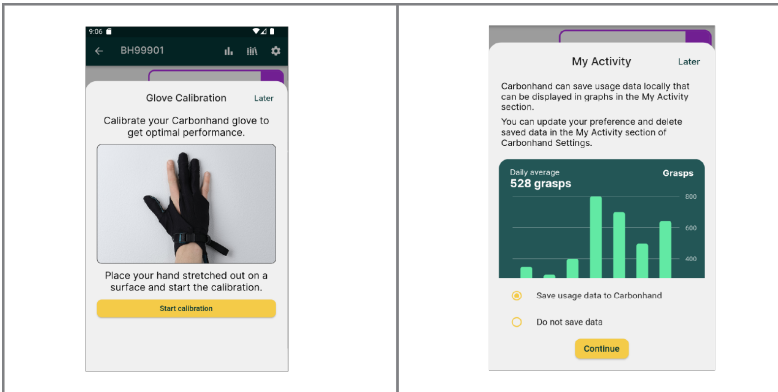

When you have connected to the app for the first time, you will be asked to calibrate your glove and to choose your settings for data storage.

11.2 General settings

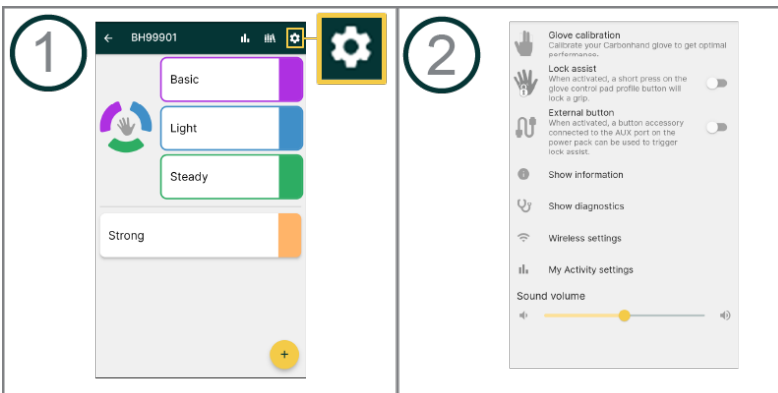

In General settings you can perform a glove calibration. Turn Lock assist and the External Activation button on or off. Find information and show diagnostics about your Carbonhand. You can also find the Wireless settings and change your settings regarding data storage under "My activity settings".

Note: Warning sounds will always be on regardless of sound volume.

Note: To receive the latest firmware updates your Carbonhand must be connected to Wi-Fi.

11.3 Create a new profile

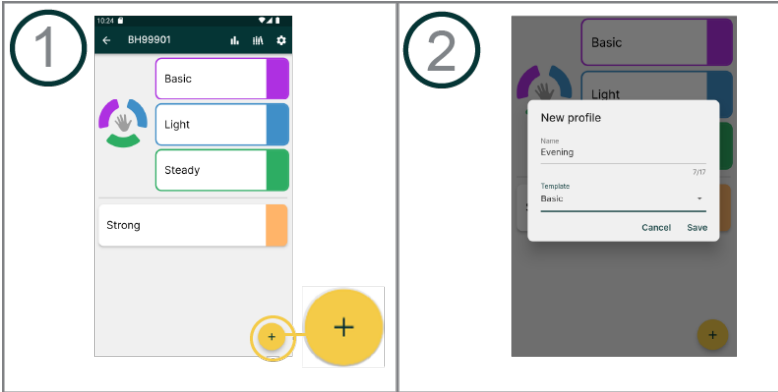

1. Click on the plus sign and enter a fitting name to your newly created profile.
2. Choose one of the 4 templates.

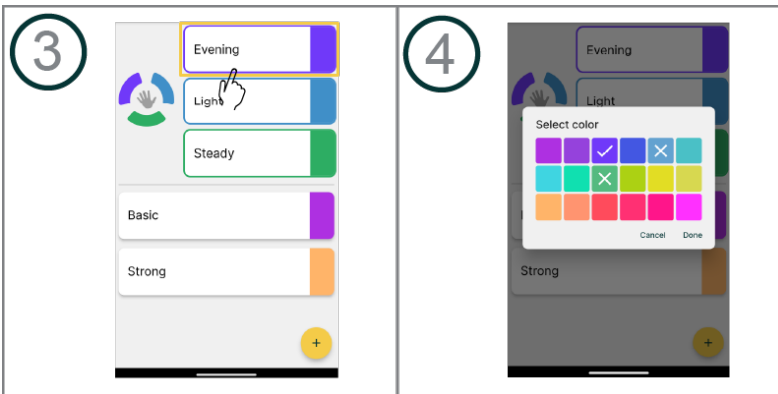

3. Drag the newly created profile to one of the three main slots.
4. Click on the color next to the profile to change it.

11.4 Edit profiles

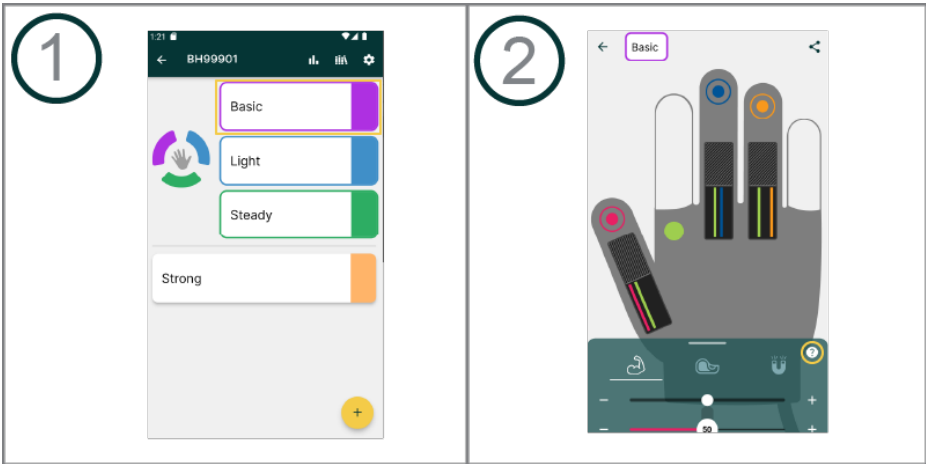

Maximum Force: The higher this setting is, the more strength is provided by Carbonhand.



Stickiness: The higher this setting is, the more Carbonhand tends to stick to objects. Higher settings of stickiness can make it difficult to release the grip.



Responsiveness: The higher this setting is, the more rapidly Carbonhand will react to grasps.

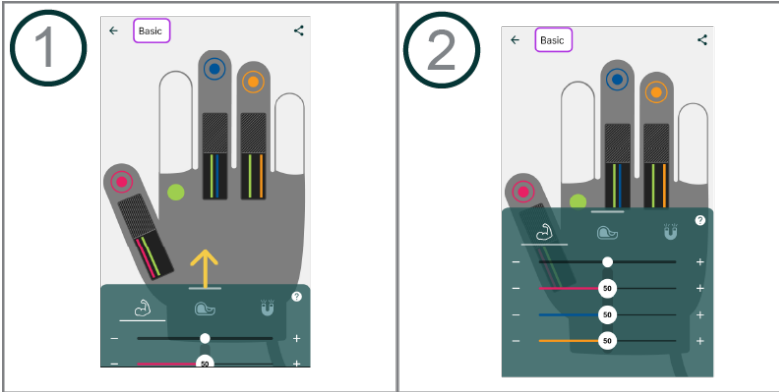

Note: You can adjust the settings for all fingers at once or for each finger individually.

11.5 Linking sensors

Individual sensors can be linked together and thereby activate multiple fingers.

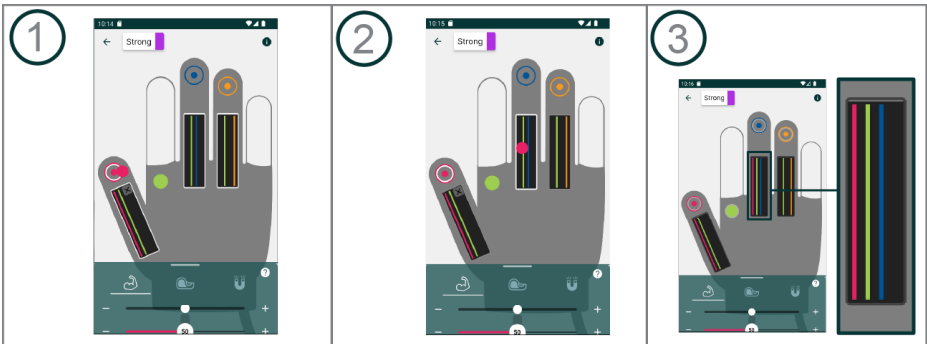

Note: The colored circles in the illustrations represent the sensors.

1. Press and hold the sensor that you want to link. The sensors will flash with a white circle around them when they are ready to be linked.
2. Drag the selected sensor to the finger you want to activate.
3. A line with the color of the sensor will be visible in the black box of the finger that you linked it with.

11.6 My Activity

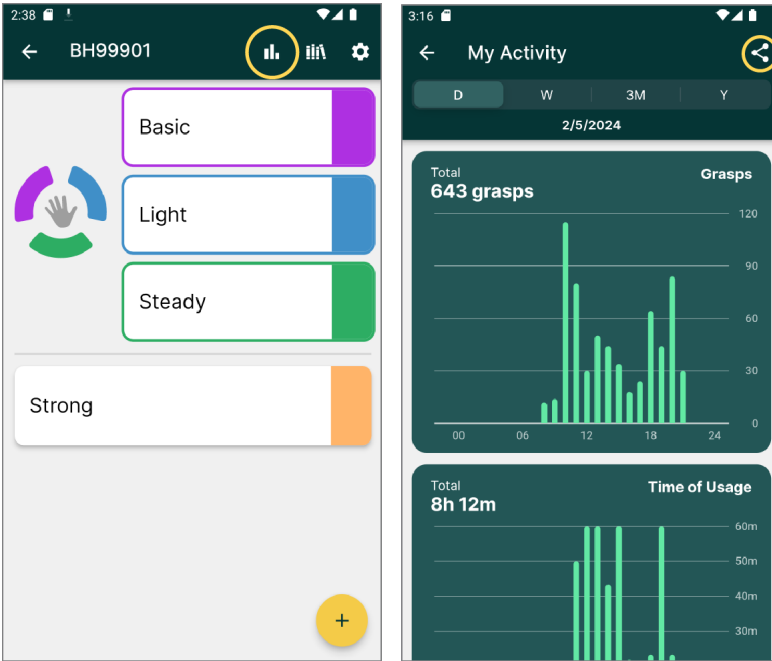

Click on the "My Activity icon". In here you can keep track and monitor your own usage statistics for Carbonhand. If you want to save or share your statistics with someone click the "share icon" and choose the options that works best according to your phone settings.

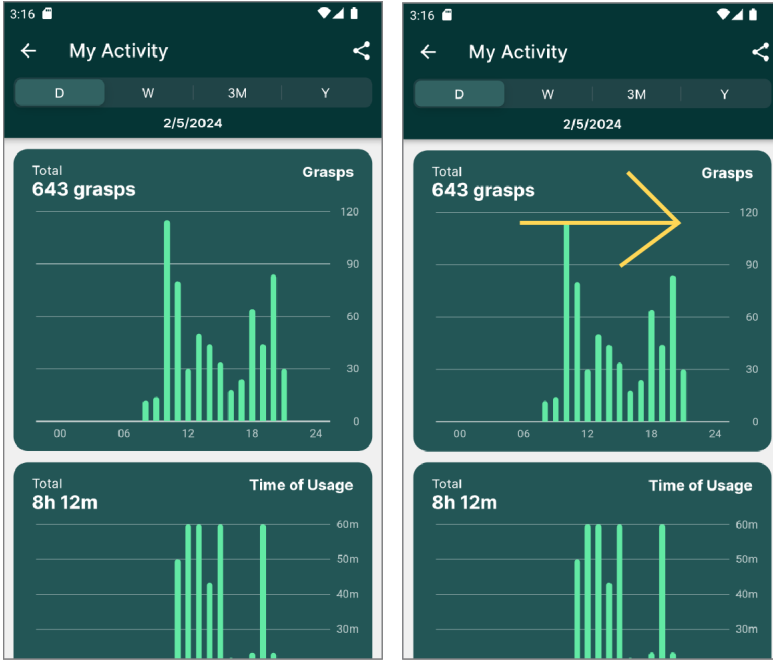

Your activity is displayed in two graphs, one that shows the total number of grasps and one that shows how long you have been using the glove. You can choose the time intervals from one day, one week, three months and one year. By swiping to the right you can go back in time and see your statistics for the chosen time interval.

11.7 Remote configuration

The Remote Configuration feature allows you to get help configuring your Carbonhand from a person in another location.

11.7.1 Inviting someone to assist you with Remote configuration

Schedule a phone call or a virtual meeting with the person assisting you with the configuration of the glove so that you can communicate with each other during the Remote configuration session.

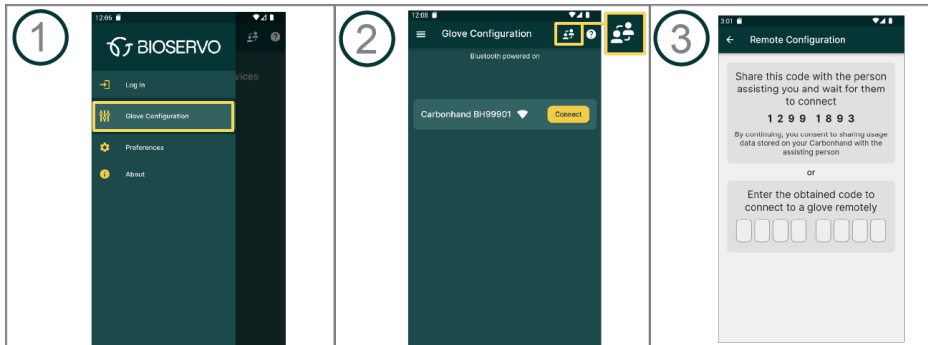

1. Open your Bioservo app and select “Glove configuration” from the main menu.
2. Click on the icon for Remote configuration.
3. Share the code that comes up on your screen with the person assisting you with the configuration of the glove.

Once the person has entered the code on their phone they will be connected to your Carbonhand through your phone. All configurations made by the person who is assisting will be shown on your phone.

11.7.2 Assist someone with a remote glove configuration

All configurations you do will be happening in real time and the person you are assisting will be able to feel the impact of your configurations.

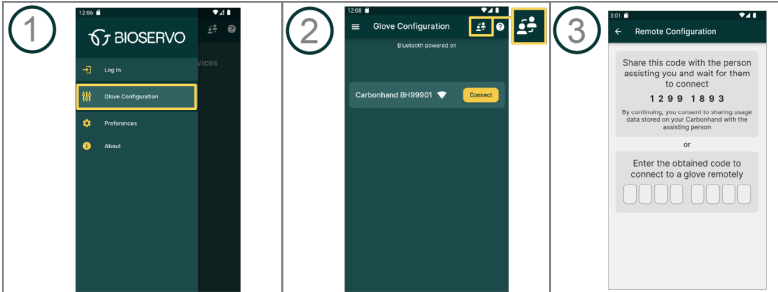

1. Open your Bioservo app and select “Glove configuration” from the main menu.
2. Click on the icon for Remote configuration.
3. Ask the person you are assisting for the code displayed on their phone. Enter the code that you are given.

You are now connected to the Carbonhand of the person who you are assisting. All configurations that you do will be shown on their phone.

12. To clean Carbonhand



No other maintenance of the product than cleaning can be performed by the user.

Clean Carbonhand and it's parts when needed.

12.1 To clean the glove

Clean the glove with water and mild detergent and rinse.

Before use, make sure that the glove and its parts are completely dry. Straighten the fingers on the glove by pulling gently at the fingers, and attach the Power unit according to chapter 4 "To assemble Carbonhand".

For tough stains the glove can be machined washed. Keep in mind that repeated machine washing can reduce the life span of your glove. Wash the glove separately.











Do not use fabric softener



Always wash the glove in the supplied padded washing bag. This prevents damage to the glove and the washing machine.

Hand wash or machine wash the glove according to the below instruction.

	Gentle cycle for synthetics
	Do not centrifuge
	Do not use detergent with bleach
	Do not tumble dry
	Do not iron
	Do not dry clean
	Do not wring
	Hang dry in room temperature

12.2 To clean the arm straps

Hand wash or machine wash the arm straps in the supplied padded washing bag according to instructions on the label. The arm straps must be closed and no velcro exposed during washing.

12.3 To clean the carry solution

Remove the Power unit from the carrying solution before washing it. Wash the carry solution according to the instructions located on the label on the carry solution.

12.4 To clean the Power unit

Clean the Power unit with a damp cloth. If necessary, use mild detergent. Do not use any abrasive detergents or cleaning equipment such as a scouring pad.

13. Carbonhand parts

Product/Size	Reference number	Explanation
Power Unit	TI-110	Controls and powers the Carbonhand
Carry solution Small/Medium	TI-121	Used to carry and protects the power unit
Carry solution Large/Extra Large	TI-132	Used to carry and protects the power unit
Glove Right Extra Small	TI-111	
Glove Right Small	TI-112	
Glove Right Medium	TI-113	
Glove Right Large	TI-114	
Glove Right Extra Large	TI-115	
Glove Left Extra Small	TI-116	
Glove Left Small	TI-117	
Glove Left Medium	TI-118	
Glove Left Large	TI-119	
Glove Left Extra Large	TI-120	
Arm Strap Small	TI-122	Keeps the Glove cord attached to the arm
Arm Strap Medium	TI-123	Keeps the Glove cord attached to the arm
Arm Strap Large	TI-124	Keeps the Glove cord attached to the arm
Charger	TI-164	Used to charge Carbonhand
Soft Case	TI-128	Used to store and protect the Carbonhand
Hard Carry Case	TI-129	Used to store and protect the Carbonhand
Power Unit Sleeve	2730	Holsters the Power unit
Shoulder Straps	2694	Used to attach back carry solution
Belt Small/Medium	2695	Used to attach hip carry solution
Belt Large/Extra Large	289	Used to attach carry solution

13.1 Accessories

Product/Size	Reference number	Explanation
Padded washing bag	TI-66	Used while machine washing
Carbonhand button Small Blue	TI-130	
Carbonhand button Large Blue	TI-131	
Carbonhand button Small Black	TI-138	Used for external activation
Carbonhand button Large Black	TI-139	Used for external activation

14. Troubleshooting

Problem	Solution
Carbonhand does not start	Make sure that the battery is fully charged.
Nothing happens when I grasp an object	Make sure that the force adjustment is not set to minimum
The system is unresponsive	If none of the above solutions are successful or the sensors does not activate any fingers, press and hold the on/off button for 7 seconds to shut Carbonhand down. Restart the system.

Problem	Reason	Acoustic notification
Acoustic notification together with the last bar on the battery led blinking	Battery level low	3 beeps when there is 5% battery left. After 3 % a constant beep and the system will turn of after 30 seconds
Acoustic notification and the profile indicator on the glove does not light up when changing profiles	No profile activated in the app	2 short beeps
Acoustic notification and the glove does not close when pressing the external activation button	External activation is not turned on in the app	1 short beep

If the Hand button on the glove lights up in a orange color it indicates a system failure, contact your supplier.

If you experience problems with your Carbonhand contact your supplier.

15. Technical specifications

Device	Carbonhand type C0
Rated voltage	8.2 VDC
Battery ratings	8.2 VDC Li-ion / 3.35Ah / 24Wh
Operation time	Approx. 8 hours(fully charged). May vary depending on usage
IP Class	IP 22
Altitude Max	2 000 m
Weight	Power pack + glove + Carry solution ≈ 1060g
Max total added force	≈ 20N per finger
Expected service life	
Battery	The internal battery expected service life is 2 years or 500 charge cycles(80% capacity left)
Power unit	4 Years
Glove	Up to 2 years
Warranty	
Power unit	2 years
Glove	6 Months
Contact material	
Glove	Polyamide, Elastane, Polyethylene, Silicone, leather.
Carry Solution	Polyurethane, Polyamide, Polyethylene.
Armstraps	Neoprene, Polyamide.
Ambient temperature	
Use	-5°C to +40°C
Storage	-20°C to +50°C
Ambient humidity	
Use	15% to 90% relative humidity, non-condensing
Storage	5% to 90% relative humidity, non-condensing
Charger	See separate manual for specifications
Wifi/Bluetooth	
Frequency	2.4 to 2.5 GHz
Protocols	802.11 b/g/n / Bluetooth 5.1

16. Declaration of Conformity



DECLARATION OF CONFORMITY

MANUFACTURER Bioservo AB
ADDRESS Torshamnsgatan 35, 164 40 Kista, Sweden

DECLARE THAT THE FOLLOWING PRODUCT:

MODEL NAME Carbonhand®
TYPE C0
BASIC UDI-DI 735008216CH2DP
INTENDED USE Grasp assistance
PRODUCT CLASSIFICATION Class I (rule 1 & 13)

SERIAL NUMBER

MAIN HARMONIZED STANDARDS

USED: IEC 60601-1:2005/AMD1:2012, IEC 60601-1-11:2015,
IEC 60601-1-6:2010/AMD2:2020,
IEC 62366 1:2015/AMD1:2020,
EN 60601-1-2: 2015

FOLLOWING THE PROVISIONS OF DIRECTIVE:
2014/30/EU, 2012/19/EU, 2011/65/EU

We hereby assure that the product above is in accordance with the European medical device regulation EU 2017/745.

PLACE AND DATE OF ISSUE Kista 2024-02-13

A handwritten signature in blue ink, appearing to read 'Ibrahim Deregård'.

Ibrahim Deregård
QA&RA

A handwritten signature in blue ink, appearing to read 'Petter Bäckgren'.

Petter
Bäckgren CEO

Document ID: D0004188

Issue: 10

Distributor:



Bioservo AB
Torshamnsgatan 35
SE-16440 Kista Sweden
support@bioservo.com
+46 (0)8 21 17 10

Copyright © 2024 Bioservo AB

Bioservo, Carbonhand® and the Bioservo logotype are trademarks that are registered to Bioservo AB.